



Innovative
Transport and Infrastructure
Technologies SkyWay

Development of TRANSPORT and INFRASTRUCTURE COMPLEXES SkyWay is carried out by a team of engineers and designers of SkyWay Technologies Co. (Minsk, Belarus)



COMPANY
structure

General Director

General Designer

- Engineering analysis department
- Department for rolling stock
- Project work department
- Department for safety systems and motion control
- Office for General designer projects
- Department for linear and infrastructural facilities
- Department for infrastructure, accessories and test equipment
- Chief engineer office
- General service department
- Accounting and planning department
- Human resources department
- Business development department
- Legal department
- 15 Design bureaus (over 100 design-engineers)

Principle of SkyWay Technology

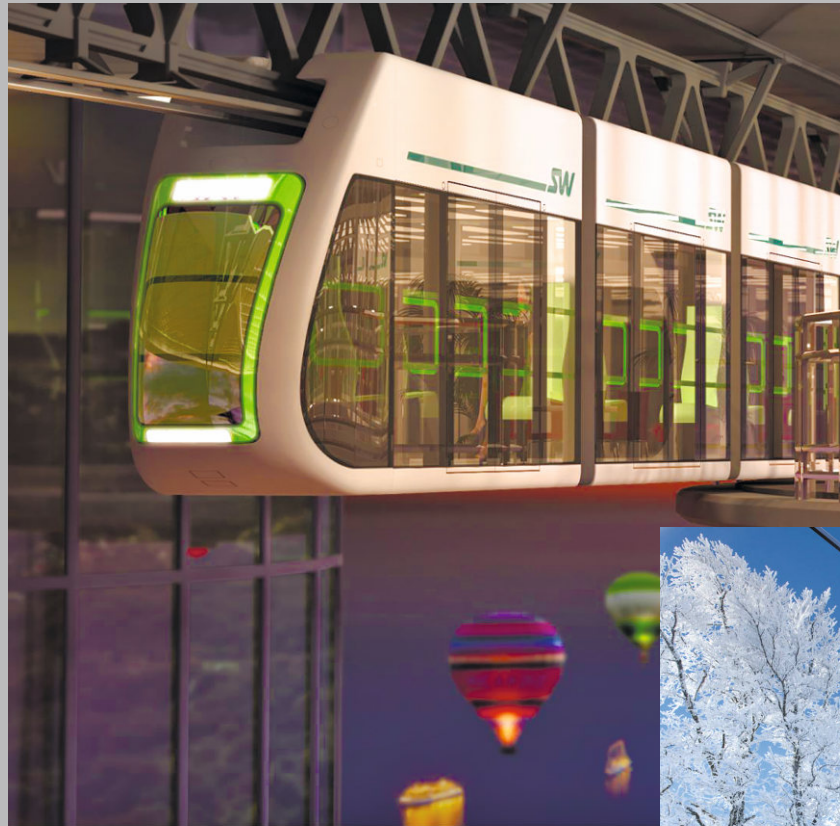

Innovative mounted and suspended wheeled vehicles operate above the ground on the innovative rail and string elevated structure

Minutes of on-site joint session of the Scientific and Technical Council for the Ministry of Transport of Russia, the Scientific and Technical Council for Transportation of Russia and the inter-agency working group on problems of rapid off-street transport (Ozyory, Moscow Region, April 12, 2002)



“...String transport system can be considered as one of the new promising non-traditional kinds of overground transport, which has previously proved its viability...”

“It is recommended as follows:

- determine the area for string transport functional application;
- carry out calculations and experimental research on stress-strain behaviour of structural elements;
- carry out calculations and experimental research on structural elements reliability (resource);
- conduct additional research on the questions concerning the following:
 - choice of drive types for transport systems;
 - vehicle movement control;
 - provision of track structure rigidity and reliability;
 - provision of rolling stock transverse stability;
 - safety provision for staff, passengers, cargo and the environment.”

ПРОТОКОЛ
высшего совместного заседания Научно-технического совета
Минтранса России, Научно-технического совета МПС России и межведомственной
рабочей группы по проблемам скоростного
внеуличного транспорта

г. Озёры, Московской области 12 апреля 2002 г.

трансп
матери
систем
(подвес
д.). Во
значит
экспер

Юници

трансп
страте

деформ
горизо
движе
в неид

(ресур
компл

вопрос

энерге

заданн

услови
различ
величи
при р
парам
путев
окаж

скорос
конст
трансп

среды
риско
сопря:

Моск
прове

предлагаемых исполнениях) и элементов

путевой структуры СТС, оценки их

номинальных и предельных технико-эксплуатационных параметров, определения

Председательствовали: Насонов А.П. - председатель НТС, первый заместитель
Министра транспорта Российской Федерации
Мишарин А.С. - заместитель председателя президиума
НТС, заместитель Министра путей сообщения
Российской Федерации

Члены НТС: Арсеёнов В.И., Белый О.В., Голубев В.А., Донченко
В.В., Иванов В.Н., Куцлов Е.К., Марьянов Ю.Г.,
Наговицын В.С., Носов В.П., Орлов О.П., Персианов
В.А., Семин А.Б., Степанов Г.И.

Приглашенные: список прилагается

ПОВЕСТКА ДНЯ:

«Развитие новых технологий перевозки грузов и пассажиров, перспективы
разработки и внедрения струнных транспортных систем (СТС),
разрабатываемых ОАО «НПК Юнического»»

(Насонов А.П., Мишарин А.С., Юницкий А.Э., Дубатова И.П., Степанов И.С.,
Ободовский Ю.М., Нарайкин О.С., Закураев А.Ф., Бирюков И.В., Стрельчук
В.К., Чепуркин Ю.В., Быков Н.В., Савин Г.А., Флегонтов Н.С., Крохин И.А.,
Петров А.В., Орешкин В.Л., Селифанов В.В., Почечуев А.П., Иванов В.Н.,
Наговицын В.С.)

1. Заслушав и обсудив доклад Юнического А.Э., разработчика струнной
транспортной системы, генерального директора - генерального конструктора ОАО
«НПК Юнического», выступления содокладчиков и специалистов, ознакомившись с
действующим испытательным стендом СТС, Научно-технический совет
Министерства транспорта Российской Федерации и Научно-технический совет
Министерства путей сообщения Российской Федерации отмечают, что струнную
транспортную систему, разрабатываемую ОАО «НПК Юнического» можно отнести к
одному из новых перспективных нетрадиционных видов наземного транспорта,
предварительно показавшего свою жизнеспособность.

Председатель НТС, первый
заместитель Министра транспорта
Российской Федерации

А.П.Насонов

Заместитель председателя президиума
НТС, заместитель Министра путей
сообщения Российской Федерации

А.С.Мишарин



“It is recommended to work out a question on development of a test base.”

“It is recommended to carry out in parallel a question on project support and financing.”

MAIN PROJECT OF SkyWay Technologies Co.: EcoTechnoPark

EcoTechnoPark is a centre for practical implementation of innovative technologies SkyWay, their international assessment and certification.

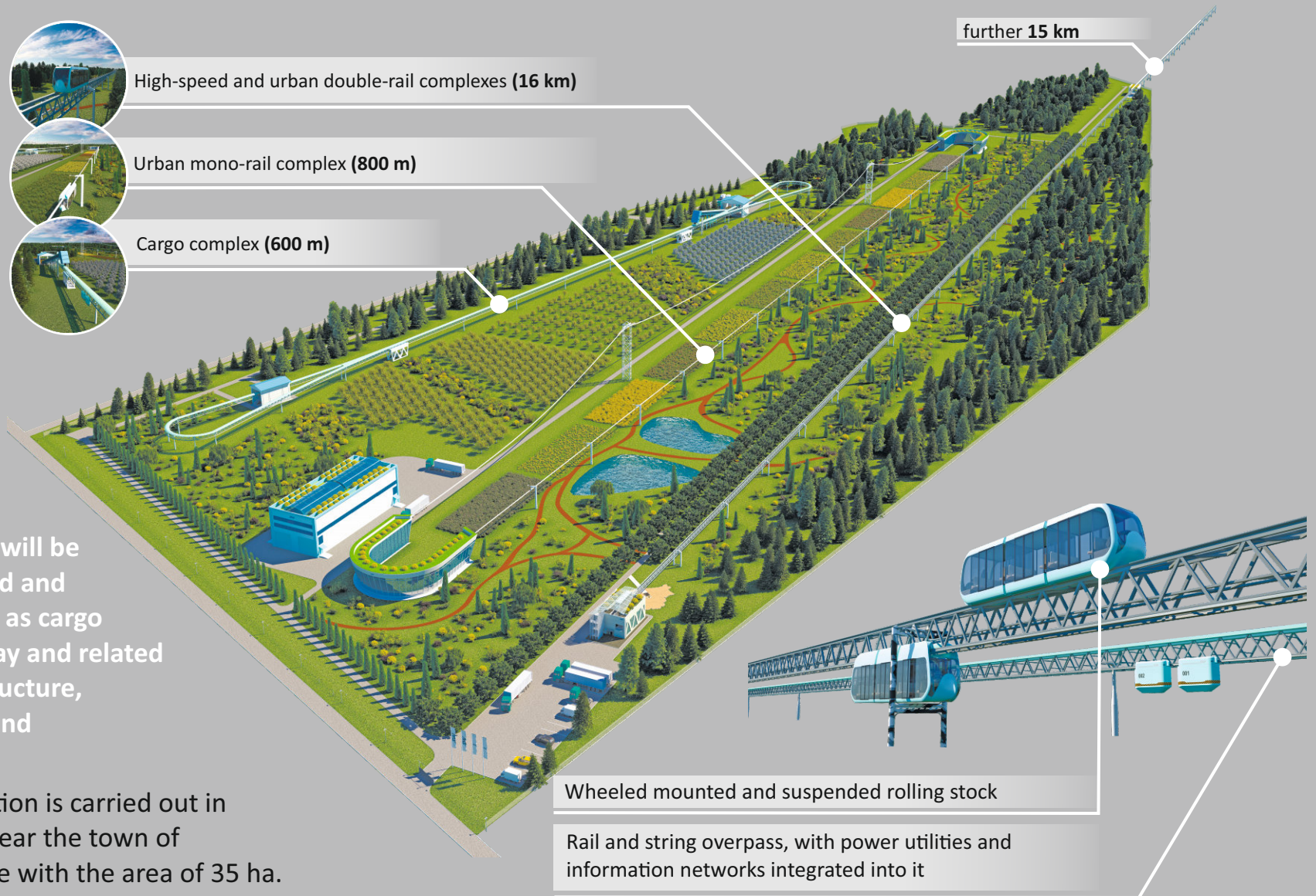

In EcoTechnoPark, there will be demonstrated high-speed and urban passenger, as well as cargo transport systems SkyWay and related communications infrastructure, including ecogenic bio- and agro-technologies.

EcoTechnoPark construction is carried out in the Republic of Belarus near the town of Maryina Gorka, at the site with the area of 35 ha.

Main Project of SkyWay Technologies Co.:
EcoTechnoPark – demonstration, experimental and industrial
development of innovative technologies SkyWay (over 100 know-how)

Current stage of EcoTechnoPark construction
(January 2016; start of construction – September 2015):



- Construction project completed

- The right to use the land plot obtained, as well as all the required permits to carry out construction works, laying of the mains cable for electricity supply and a water supply line

- Engineering and geodesic surveys for transport elevated structures and mains cables for water and electricity supply completed

- The process of constructing walls for the first floor and interflooring for the transport node, coupled with a terminal anchor support, finished. 16 out of 18 intermediate overpass supports for urban passenger transport system (acceleration area for high-speed SkyWay) installed.

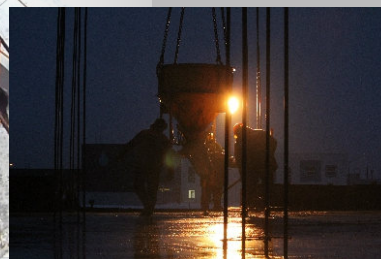

Main Transport Solutions of Innovative Technology SkyWay

HIGH-SPEED SkyWay (mounted and suspended)

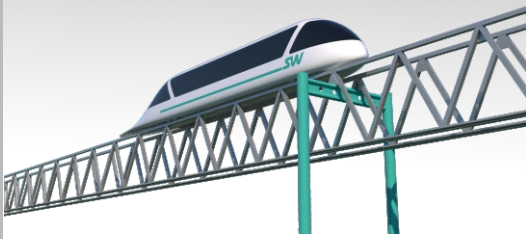

Designed for intercity passenger transportation over long distances (up to 10,000 km).

Energetically highly-efficient, low-noise, safe, eco-friendly.

Speed: up to 500 km/h

*Performance – 500,000 passengers per day and more.
Maximum gradient – 20%*

URBAN SkyWay (mounted and suspended)



Designed for passenger transportation over short distances (up to 200 km). It is harmoniously included into urban development.

Energetically highly-efficient, low-noise, safe, eco-friendly.

Speed: up to 150 km/h

*Performance – 25,000 passengers per hour and more.
Maximum gradient – 45%*

CARGO SkyWay (mounted and suspended)

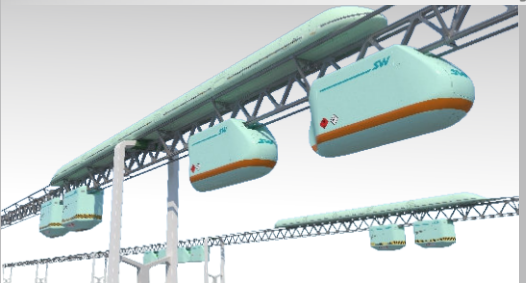

Designed for cargo transportation (including on hard-to-reach and underdeveloped territories).

Energetically highly-efficient, low-noise, safe, eco-friendly.

Speed: up to 150 km/h (suspended) and up to 500 km/h (mounted).

*Performance – 200 mln tons per year and more.
Maximum gradient – 60%*

SkyWay compared to other means of transport

Capital expenses

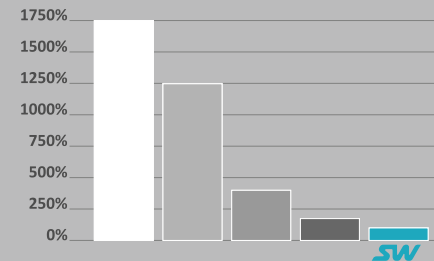

Environmental pollution

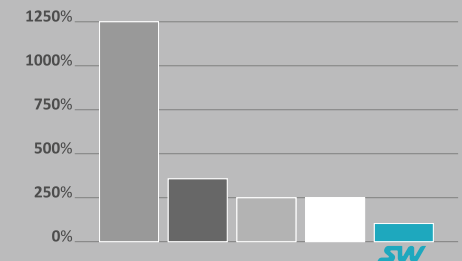

Operating expenses

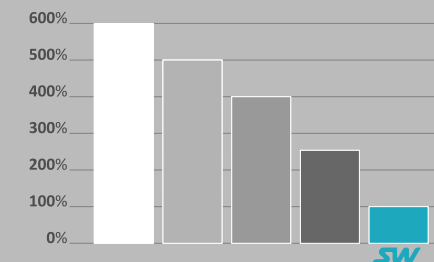

Traffic accident rate

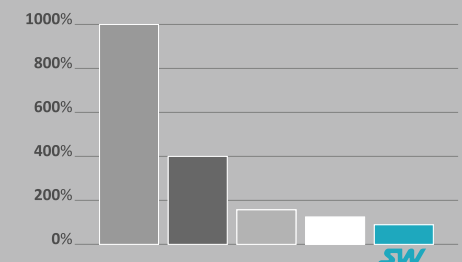

- Magnetic levitation train
- Mono-rail track
- Automobile transport
- Railway transport



According to the estimate of the Russian Academy of Sciences, innovative transport technology SkyWay is the most cost-effective, environmentally friendly and safest of all known and advanced transport systems

SkyWay Eco-Friendliness



there is no earth embankment (low-pressure dam)



minimal local land acquisition (by times)



preservation of natural ecosystems and geobiocenosis



reduced amount of hazardous emissions into the atmosphere (by times) due to less energy consumption



increased noise-, vibro- and electrical safety (by times)



resource consumption — saving of raw materials, land, energy, labour and finances

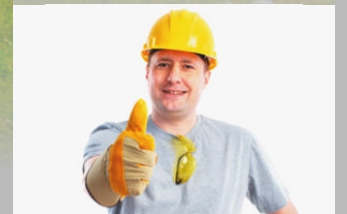

The basis of SkyWay technology is innovative string rail

Types of STRING RAILS and corresponding TRACK STRUCTURE DESIGNS

A flat rail head and a cylindrical steel wheel ensure minimal energy consumption for movement

Design variant of a semi-rigid string rail

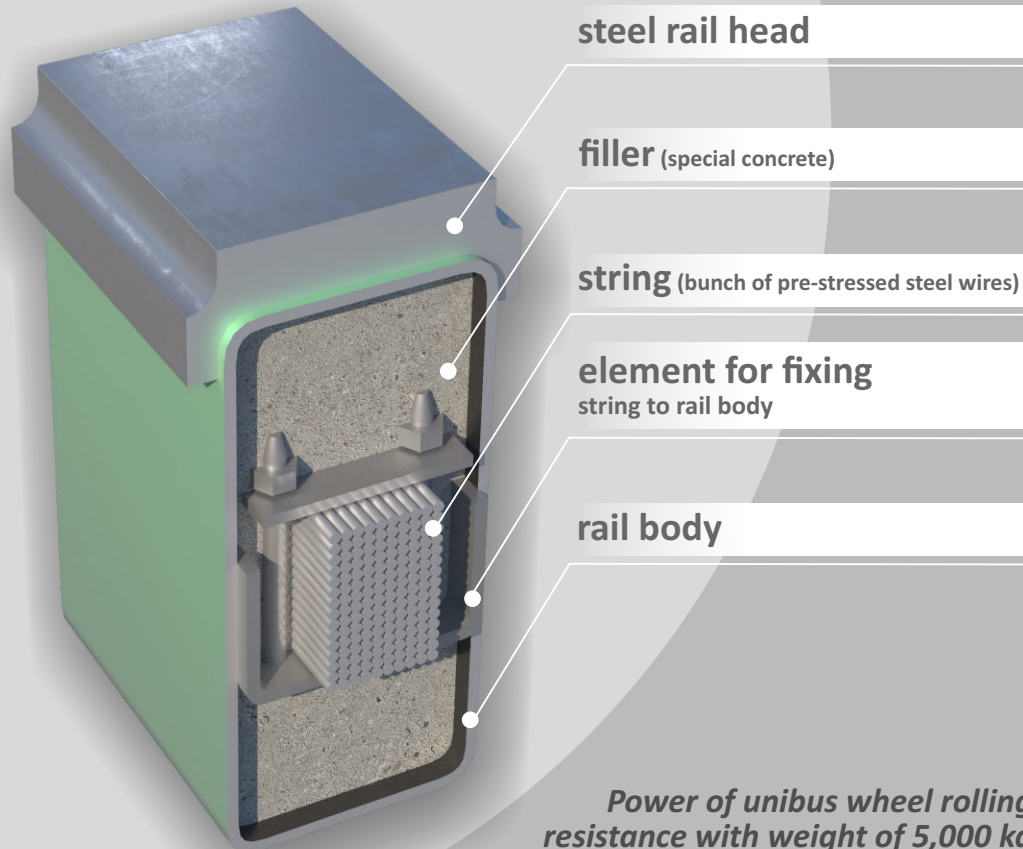

Power of unibus wheel rolling resistance with weight of 5,000 kg at the speed of 450 km/h:

$$W_{w.r.} = M \cdot g \cdot k_{w.r.} \cdot V = 5,000 \text{ kg} \cdot 9.81 \text{ m/s}^2 \cdot 0.0015 \cdot 125 \text{ m/s} \approx 9.2 \text{ kW}$$

Compare: when using pneumatic machines with $k_{w.r.} = 0.18$ (for $V = 450 \text{ km/h}$), $W_{w.r.} \approx 1,100 \text{ kW}$

Design variant:

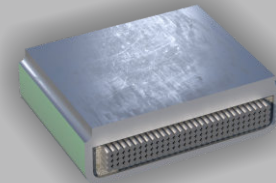

FLEXIBLE RAIL

FLEXIBLE UNCUT TRACK STRUCTURE

Motion speed: from 30 (on support) up to 150 km/h
Relative structural rigidity: 1/100–1/500
Track structure curve radius: R=100 (on support)...2,000 m

It is not an analogue to cable railway:

- use of rail (lower rolling resistance);
- lower energy consumption for movement (by 3–5 times less);
- possibility of using a gravity engine and gravity brake (reduced energy consumption by another 3–5 times);
- high durability (by 5–7 times higher).

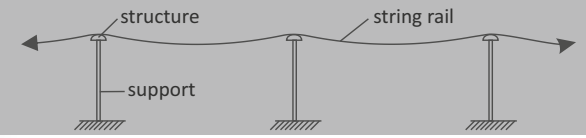

Design variant:

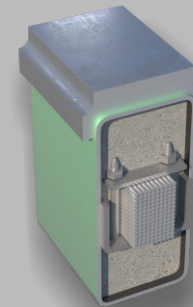

SEMIRIGID RAIL

SEMIRIGID UNCUT TRACK STRUCTURE

Motion speed: from 50 up to 150 km/h
Relative structural rigidity: 1/500–1/2,000
Track structure curve radius: R=500...5,000 m

Track structure design follows the design of a hanging bridge, combining its all main elements:

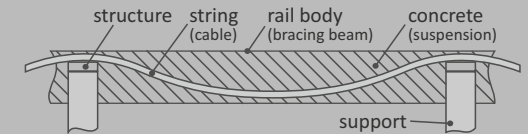

Hanging bridge:

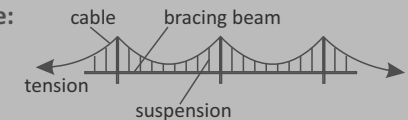

Design variant:

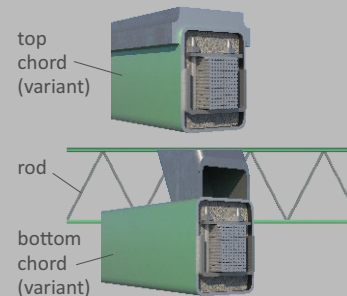

RIGID RAIL (TRUSS)

RIGID UNCUT TRACK STRUCTURE

Motion speed: from 100 up to 500 km/h
Relative structural rigidity: 1/1,000–1/10,000
Track structure curve radius: R=5,000...50,000 m

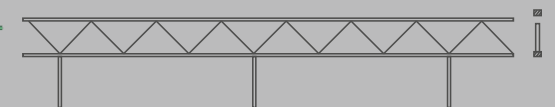

SkyWay Technology and Conventional Beam Overpass

Split overpass
(conventional bridge)

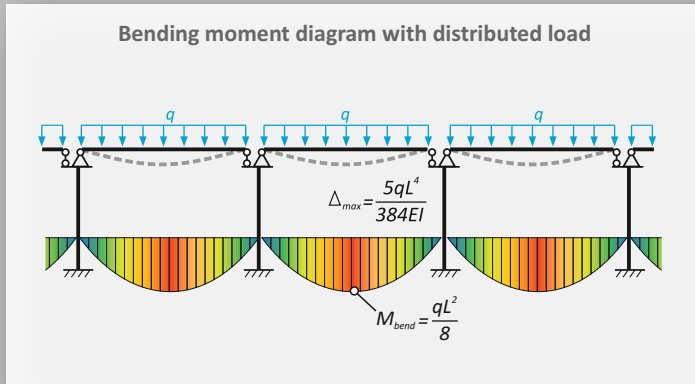

Innovative uncut pre-stressed overpass
(SkyWay technology)

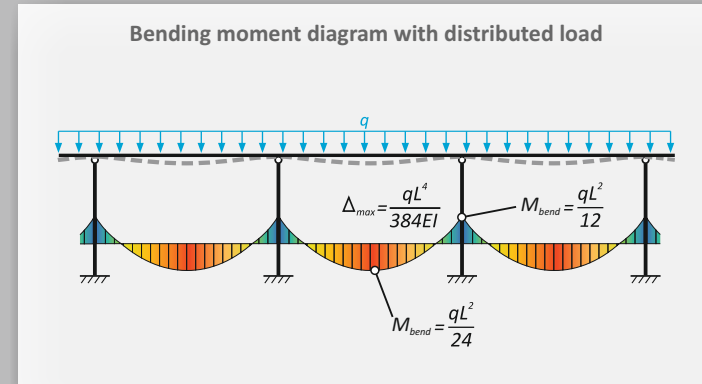

With equally distributed load, SkyWay overpass is 5 times more rigid (smoother) and 3 times stronger than a conventional bridge

Bending moment diagram with concentrated force

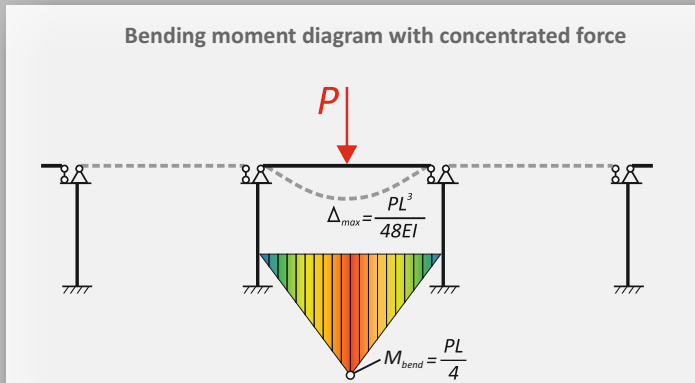

Bending moment diagram with concentrated force

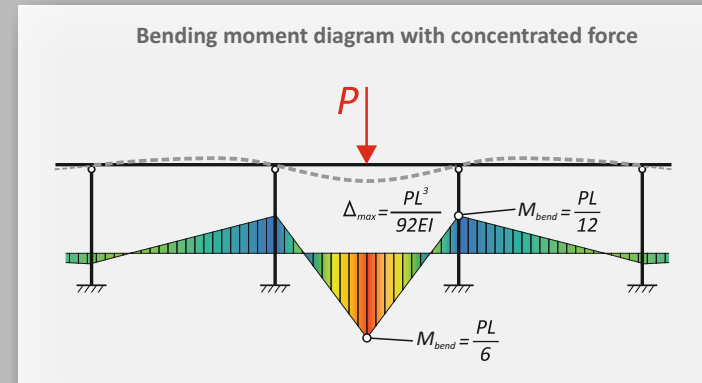

With equal concentrated force, SkyWay overpass is twice more rigid (smoother) and 1,5 times stronger than a conventional bridge

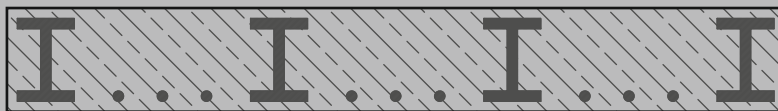

Solid roadbed gives additional load onto supports.
90% of load in a conventional overpass is **its own weight**.



Only 10% of load in a **SkyWay** overpass is **its own weight**.

SkyWay overpass decreases the amount of building materials and, consequently, reduces the cost by 15 times compared to a conventional overpass

Advantages of Steel Wheels SkyWay

Conventional railway wheel

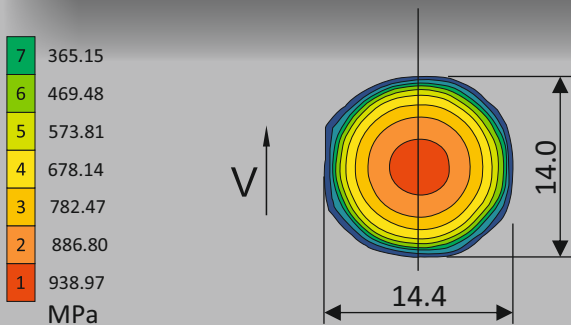
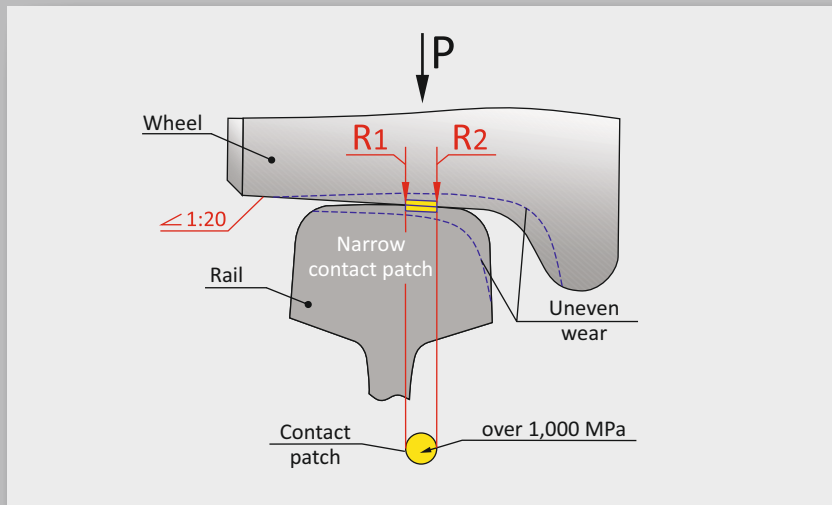

Increased wheel wear and noise due to the following:

- big contact stresses (1,000 MPa and more), caused by a small size of contact patch;
- slipping in the contact patch, caused by a difference of seating diameters in the conical surface of the wheel;
- operation of brake mechanisms (brake shoes cause additional wheel thread wear);
- big static and dynamic wheel loads combined with inevitable track irregularities;
- a rigid wheel pair prone to self oscillations, which increase wear and noise;
- symmetrical load application onto the rail head.

Innovative unibus wheel

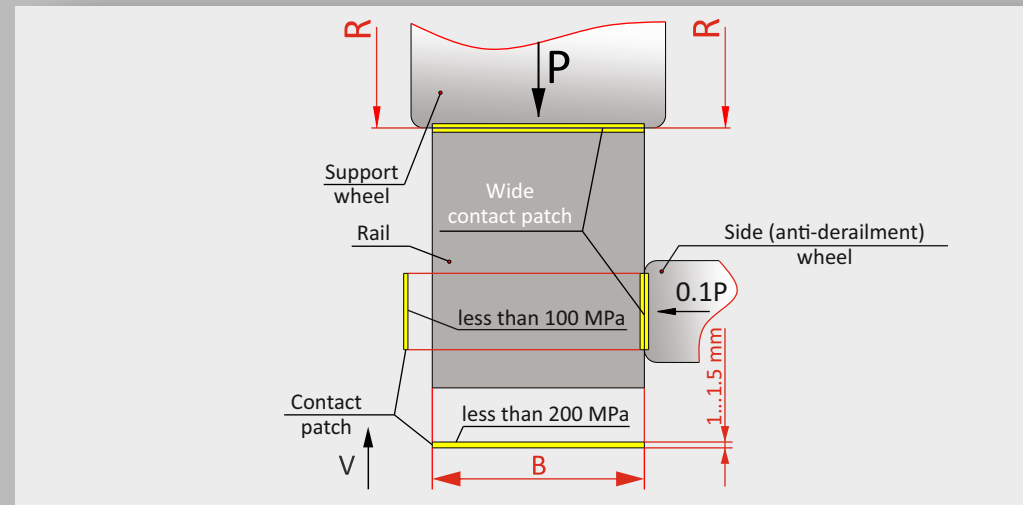

Calculation of contact stress for high-speed Unibus with gross weight of 5 tons

$$\sigma_k = 0.418 \cdot \sqrt{\frac{P \cdot E}{B \cdot q \cdot R}} = 0.418 \cdot \sqrt{\frac{1,250 \text{ kgf} \cdot 2.1 \cdot 10^6 \text{ kgf/cm}^2}{8 \text{ cm} \cdot 0.8 \cdot 26 \text{ cm}}} = 1,660 \text{ kgf/cm}^2 = 163 \text{ MPa}$$

- P – wheel load;
- E – effective elastic modulus;
- B – width of wheel supporting part;
- R – wheel radius;
- q – coefficient of contact irregularity by length

Advantages of SkyWay transport wheels:

- insignificant contact stress (less than 200 MPa) due to a wide contact patch (by rail head width);
- no slipping in the contact patch (cylinder rolling along the plane);
- disk brake mechanisms and ABS, which prevents wheels locking;
- small wheel load and absence of joints on the track;
- symmetrical rail head wear (vertically and horizontally);
- minor wheel rolling resistance due to a narrow contact patch (in direction of wheel rolling).

PRE-STRESSED string track SkyWay is the optimal solution for thermal distortion compensation

$$t_{max} = +50^{\circ}\text{C},$$

$$t_{mix} = -50^{\circ}\text{C}$$

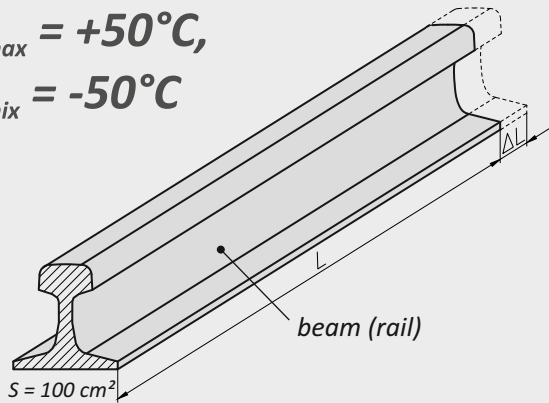

Under thermal effects:

- absolute deformation

$$\Delta L = \alpha \cdot L \cdot \Delta t$$

- relative deformation

$$\varepsilon = \frac{\Delta L}{L} = \alpha \cdot \Delta t$$

For steel, thermal coefficient of linear expansion (per 1°C)

$$\alpha = 0.000012$$

with $\Delta t = 100^{\circ}\text{C}$, $\varepsilon = 0.0012 = 1/833$
(extension will make 1.2 m per 1 km)

Tests of a rigidly restrained beam for strength and stability under thermal effect ($\Delta t = 100^{\circ}\text{C}$)

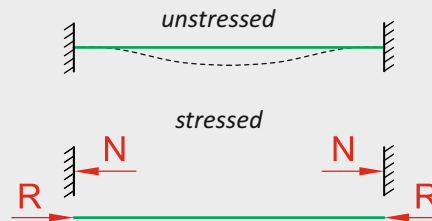

Test for strength:

- compression strain of longitudinal fibres:

$$\sigma = E \cdot \varepsilon = E \cdot \alpha \cdot \Delta t \leq \sigma_{02}$$

For steel, with $E = 2 \cdot 10^6 \text{ kgf/cm}^2$ and $\Delta t = 100^{\circ}\text{C}$:

$$\sigma = 2 \cdot 10^6 \cdot 0.0012 = 2,400 \text{ kgf/cm}^2$$

Test for stability:

- longitudinal compression force arising in a restrained beam at temperature differences:

$$N = \sigma \cdot S = E \cdot \alpha \cdot \Delta t \cdot S \leq N_{crf} = \frac{4\pi^2 EI}{L^2}$$

For steel, with $S = 100 \text{ cm}^2$ and $\Delta t = 100^{\circ}\text{C}$:

$$N = 2,400 \cdot 100 = 240 \text{ tf}$$

With the pre-stressing force more than 240 tf, there will be no compression forces in the structure and it will not lose its stability

Bending moment diagrams in a pre-stressed "rigid thread" and a restrained beam with distributed load and concentrated forces

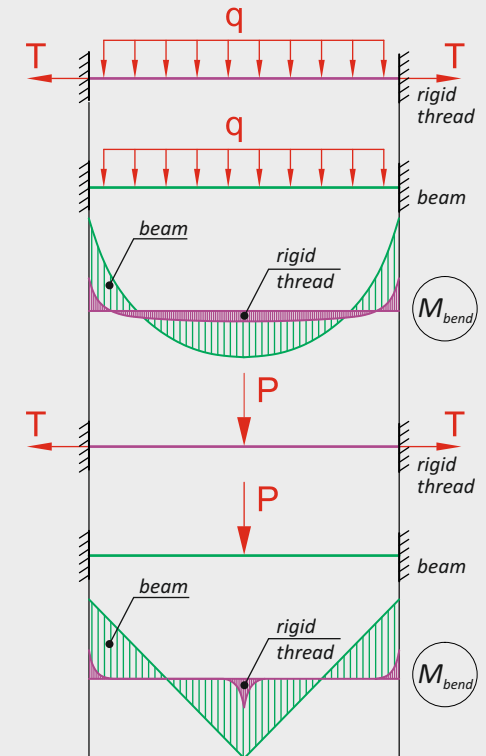

CONCLUSION: bending stress in a rigid thread is by an order of magnitude lower than in a beam

CONCLUSION: The most dangerous phenomenon when heating a rigidly restrained beam is considered the loss of its stability.

SOLUTION:

A pre-stressed beam with the rated force of $T \geq N$ 100°C ensures that even temperature difference of $\Delta t = 100^{\circ}\text{C}$ will not cause compression forces in longitudinal fibers of the beam

HIGH EVENNESS of the track is achieved due to the uncut structure of STRING RAIL between anchor supports

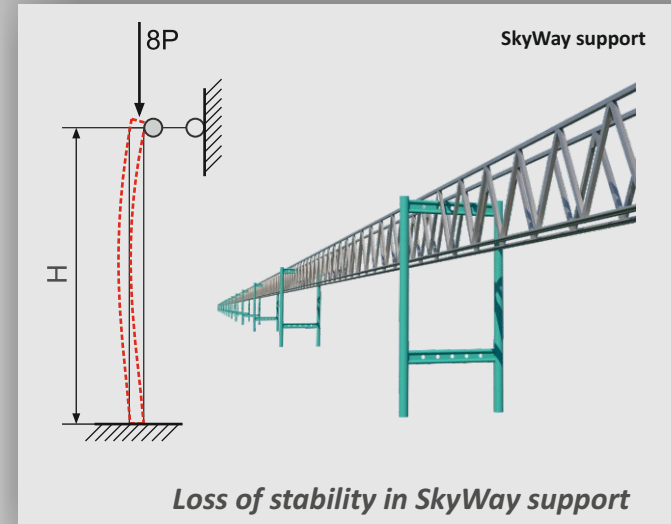
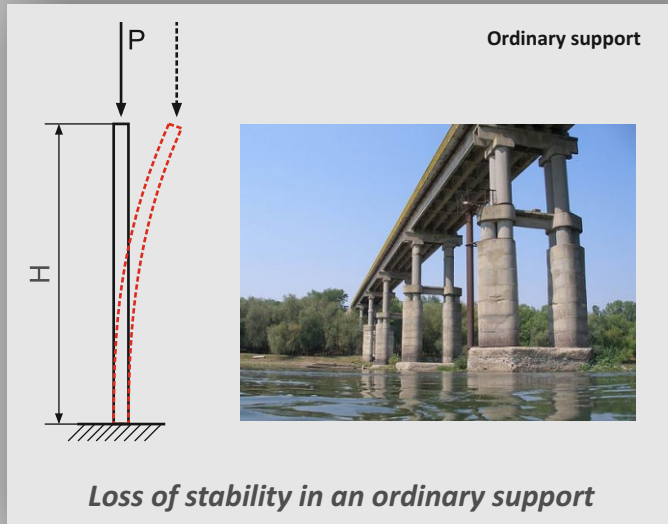

- Intermediate supports installed at a span from 25 up to 100 metres (to ensure rigidity of the uncut track structure) allow to use light structures.
- Fixing of the support top to the track structure allows to additionally increase its load-bearing capacity by 8 times.
- The amount of materials required for installation of supports can be reduced by 8 times, resulting in cost reduction by the same figure.

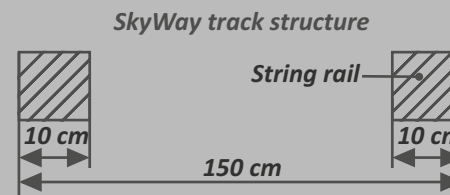
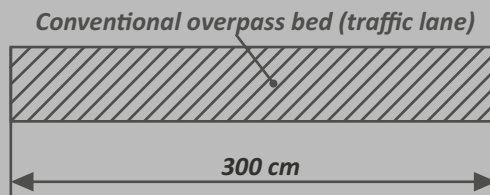

Uncut structure of the string rail in its overpass design, compared to a conventional beam overpass, REDUCES THE AMOUNT OF BUILDING MATERIALS BY 15 TIMES AND MORE

Construction cost of a conventional overpass with ordinary supports — from 100 mln USD/km

Construction cost of SkyWay overpass — from 3 mln USD/km

Smooth Movement

**SPLIT OVERPASS
(CONVENTIONAL BRIDGE)**

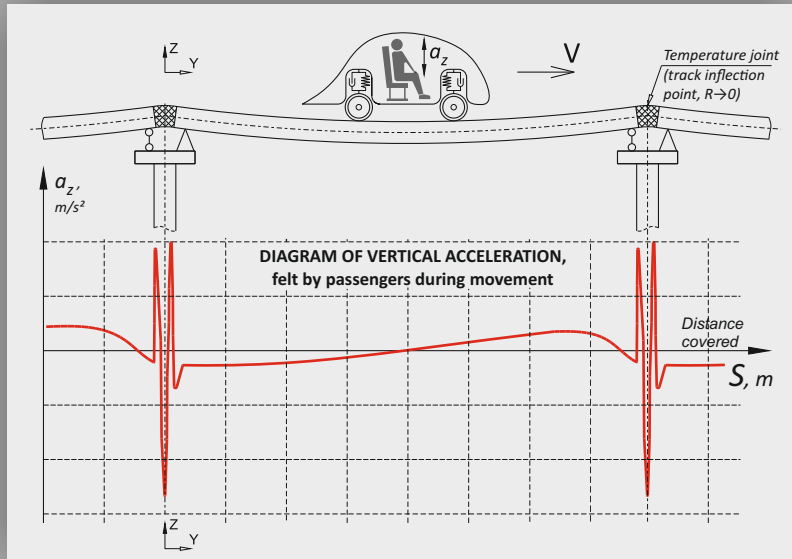

DISADVANTAGES:

- peak values of acceleration when moving through supports,
- complicated design of the supporting node with a temperature joint.

**UNCUT PRE-STRESSED OVERPASS
(SkyWay TECHNOLOGY)**

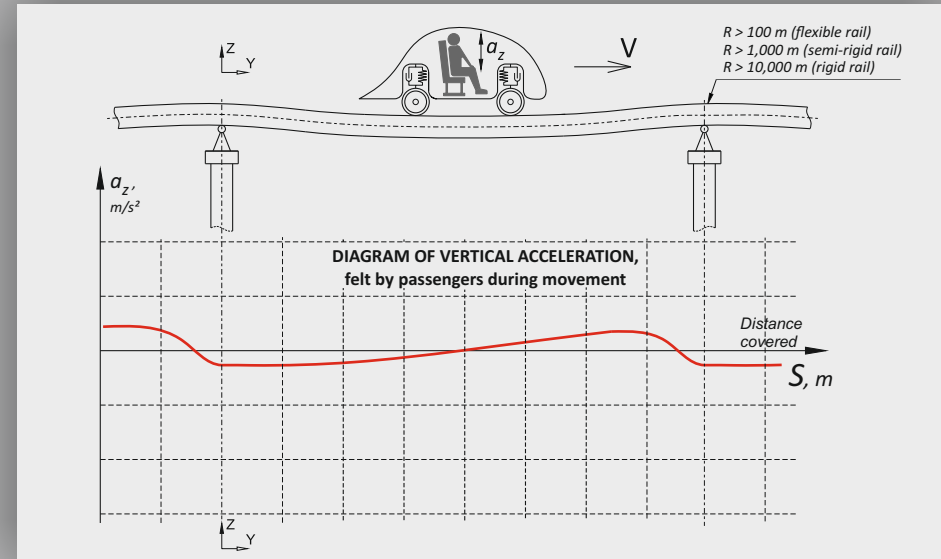

ADVANTAGES:

- smooth change of acceleration when moving through supports,
- more simple design of the supporting node.

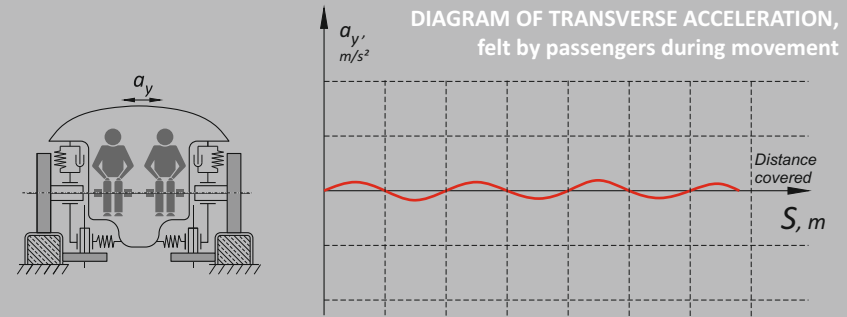
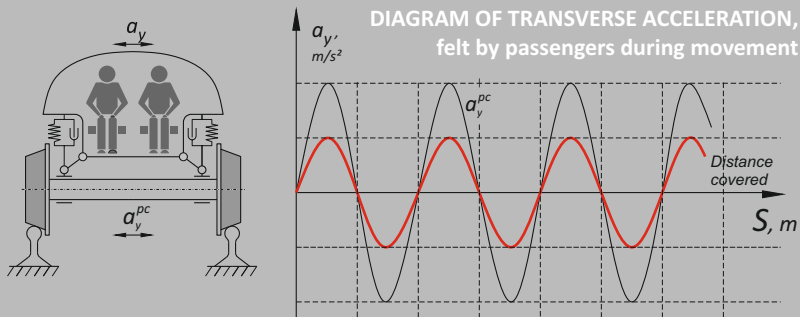

PASSENGER COMFORT IS ESTIMATED BY SMOOTH MOVEMENT W (by method of E. Shperling)

$$W = 2,7k^{10}\sqrt{T \cdot E}$$

where: k – coefficient, which depends on direction and vibration frequency,
 T – intensity of acceleration buildup, i.e. time derivative of acceleration amplitude,
 E – maximal kinetic energy, obtained by single mass of a passenger during vibration, which is numerically equal to multiplication of displacement amplitude by acceleration amplitude.

Evaluation of car movement	Index of smooth movement W
Excellent	less than 1
Good	1–2
Satisfactory (permissible for passengers)	2–3.25
Permissible for cargo	3.25–4
Impermissible	4–5
Unsafe	more than 5

Aerodynamics of a Wheeled Vehicle

Wind tunnel tests of an innovative rolling stock SkyWay (Unibus) have given the RESULT: $C_x = 0.075$

This provides saving of drive power in one vehicle SkyWay of about 600 kW compared to the most advanced alternative ground vehicles, which have $C_x = 0.2$ (for example, a sports automobile $C_x = 0.3...0.4$)

At present, SkyWay rolling stock C_x has been improved up to 0.05

$$\Delta C_x^{min} = 0.2 - 0.05 = 0.15$$

Power saving of aerodynamic resistance (at a speed of 450 km/h):

$$\Delta W_{a.r} = \frac{1}{2} \rho_{air} \cdot V^3 \cdot \Delta C_x \cdot f_m \cdot k = \frac{1}{2} \cdot 1.25 \text{kg/m}^3 \cdot (125 \text{m/s})^3 \cdot 0.15 \cdot 3 \text{m}^2 \cdot 1.1 \approx 600,000 \text{kW} = 600 \text{kW}$$

Energy (fuel) saving by one unibus (in terms of diesel fuel based on 0.25 l/kW x h) will be as follows:

600 kW x 0.25 l/kW x h = 150 l/h x 20 h = 3,000 l/day x 365 ≈ 1.1 mln l/year x 25 years (unibus life cycle) = 27.5 mln l ≈ 22,000 t/25 years, at the cost of about 20 mln USD

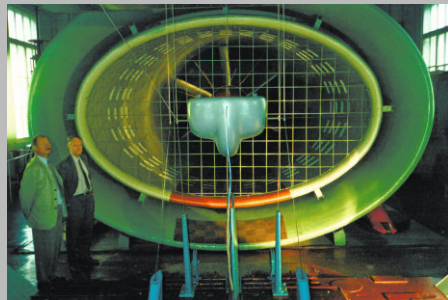

Track structure location above the ground and absence of a solid roadbed help to eliminate the main problem for high-speed transport – **aerofoil effect**

This alone allows to improve vehicle aerodynamics twofold

(Compare: with $C_x = 0.3$, as for example in a sports car Bugatti Veyron, $C_{a.r}^{450} \approx 1,200 \text{ kW}$)

For 25 years (average operation period of one vehicle), this will give saving for 1 mln unbuses (for example, nowadays there operate about 1 bln automobiles in the world): 22 bln tonnes of fuel at the cost of about 20 trillion USD

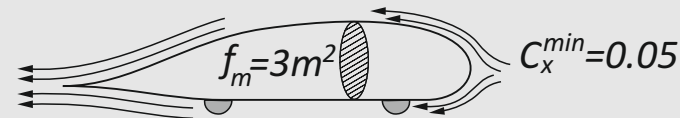
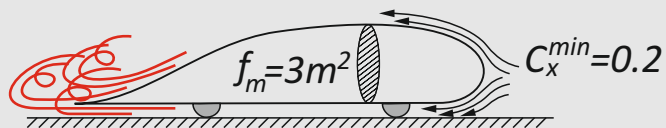

ADVANTAGES OF HIGH-SPEED SkyWay over Magnetic levitation train

High-speed SkyWay

Application of a steel wheel ensures **efficiency factor over 99.8%**

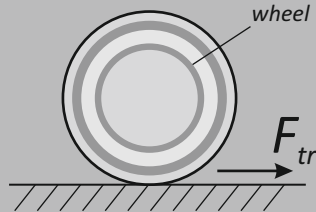

Track structure SkyWay is lighter and more cost-effective as it has a delicate roadbed, it does not require installation of electric coils and provides a simple anti-derailment system.

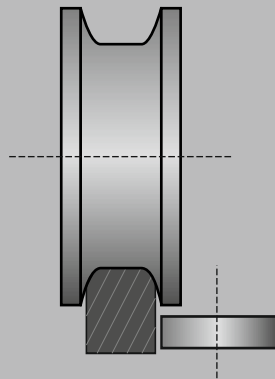

Overpass cost — from 3 mln \$/km

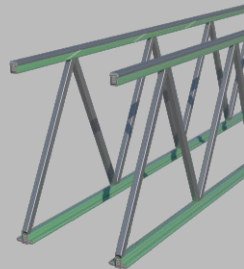

Track structure operation does not require any additional machinery, as it is capable of self-cleaning (for example, from snow and icing) and it has no complicated technical elements (electric coils and others).

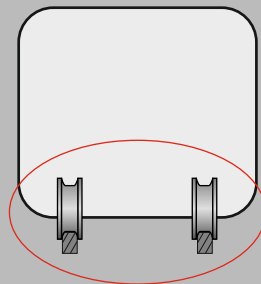

Magnetic levitation train

Application of a linear electric motor gives **efficiency factor not more than 50%** as the clearance between a rotor and a stator (for example, in Transrapid) cannot be less than 10 mm, and for an electric motor, this clearance shall not exceed 0.5 mm.

The track structure is expensive as it has a massive roadbed, requires installation of electric coils and a complicated anti-derailment system.

Overpass cost — from 50 mln \$/km

Track structure operation is more labour-consuming as it has a complicated form and includes complicated technical components (electric coils, switching devices, etc.), which require constant maintenance and machinery for cleaning the track from snow and icing.

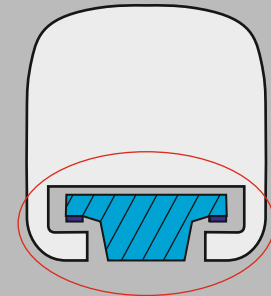
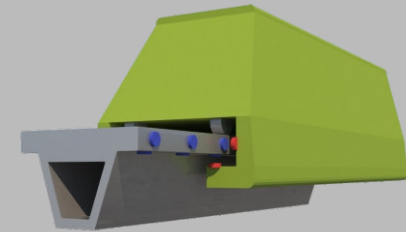
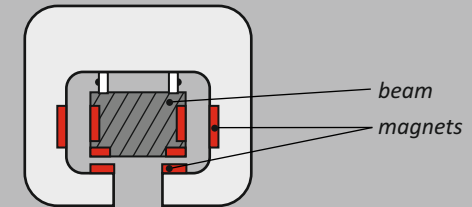
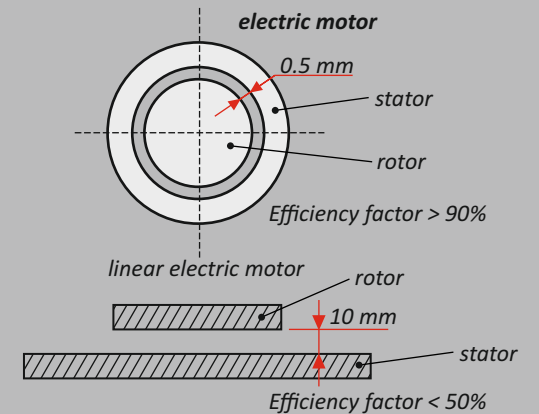

Application of Energy Conservation Law in Innovative Transport SkyWay

In terms of energy consumption, an overpass with a sagging track structure is by times more efficient than a road with a straight track structure

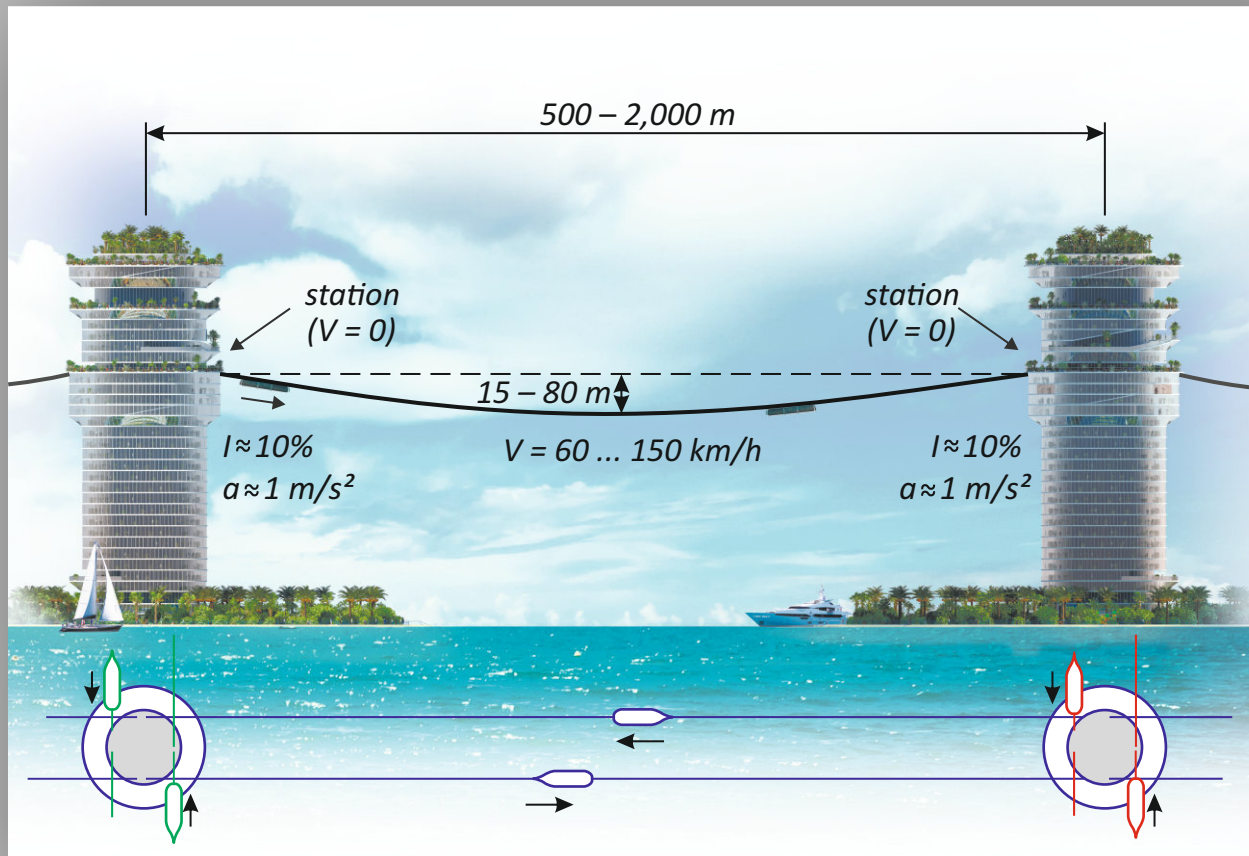

It is explained by the fact that on a downhill section of the track, the unibus does not need an engine — it is accelerated by gravity ("gravity" engine).

On an uphill section, it does not need brakes — it is slowed down by gravity ("gravity" brake).

Energy recuperation takes place without using a recuperator, as in this case there are applied laws of physics, not any mechanisms.

Efficiency factor of this recuperation is 100%.

The drive in such a type of transport system is only required for aerodynamic compensation, and to overcome steel wheels rolling resistance on a steel rail (in total, about 10 kW for a 50-seated vehicle).

Safety of SkyWay Transport Systems

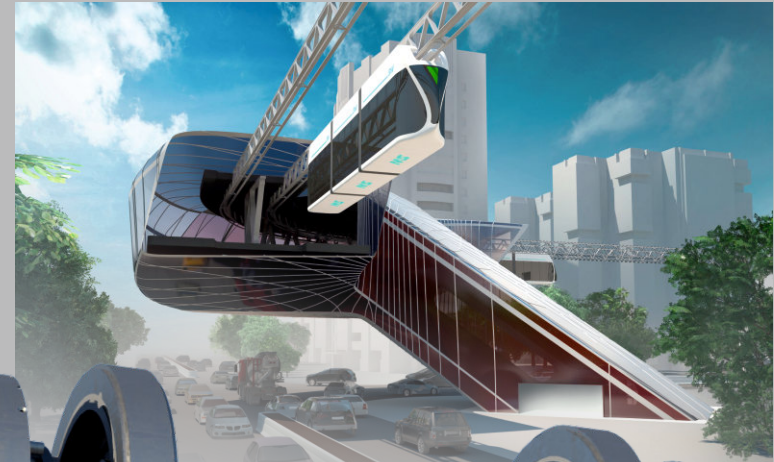

Location of track structure above the ground enhances safety of movement by about 100 times

Anti-derailment system increases traffic safety by another 10 times

High resistance to vandalism and acts of terrorism

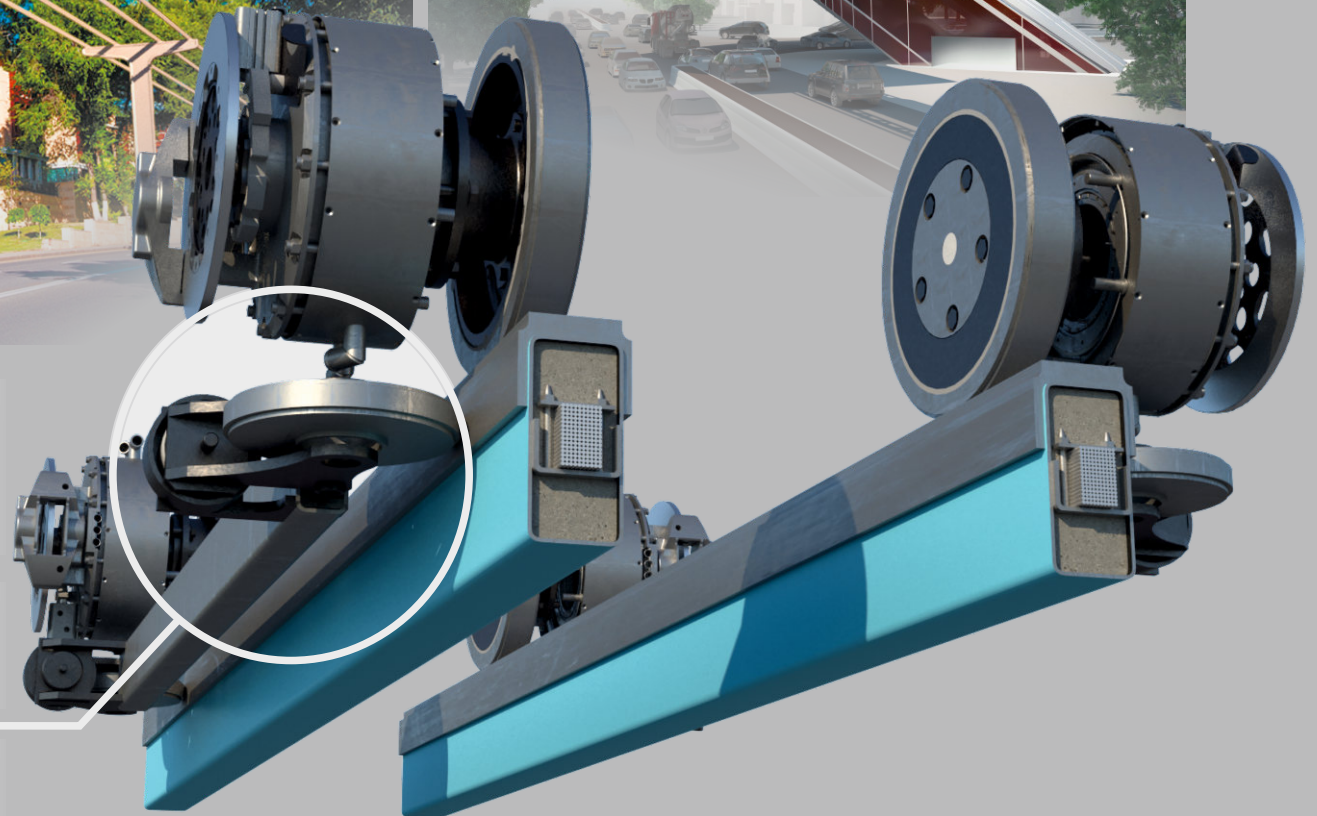

Passenger Unibus SkyWay Chassis Layout



Control Systems of SkyWay Transport Complex

The control system of SkyWay transport complex comprises a wide range of wireless and wired communications created on the basis of conventional informational and electronic technologies

Automated control systems of SkyWay transport complex

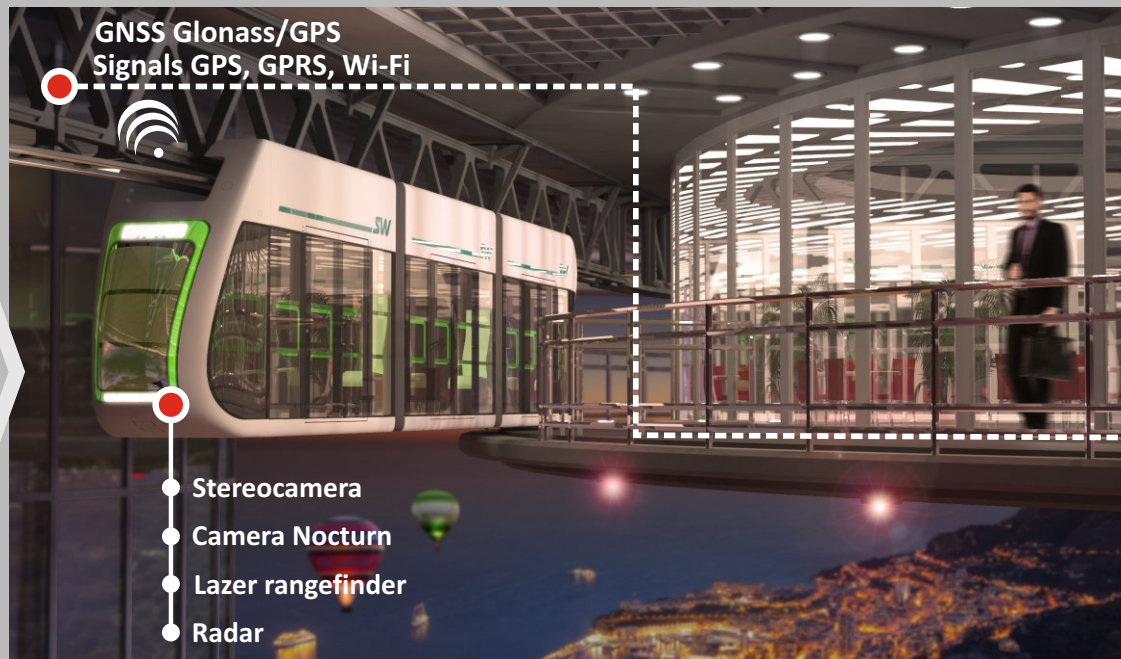

Implementation of this system will increase efficiency of traffic control, reduce non-productive cost of goods and passengers transportation, accelerate development of information structure

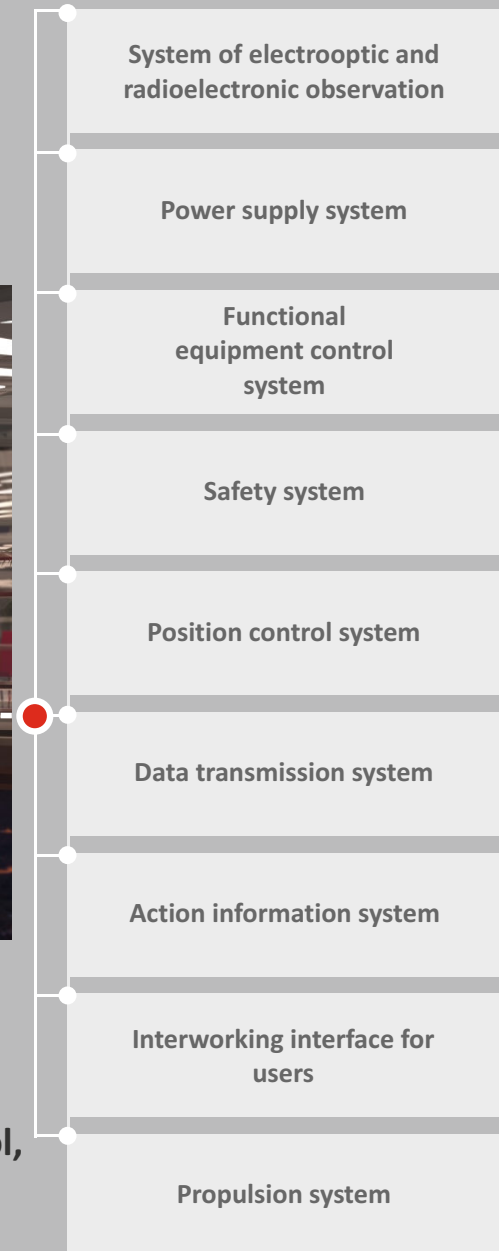

Transportation Capacity of Innovative SkyWay Transport System

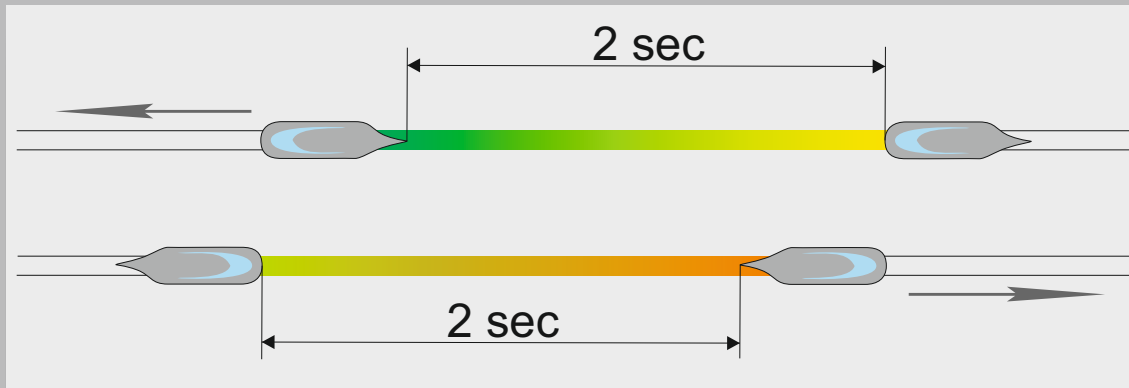

For control systems in real-time a safe time interval between unibuses equals to 2 sec.

The indicated requirements are recommended by the standards of the American organization Automated People Mover (APM) Standards Committee:

APM standard part 1 ASCE 21-05 – Operating environment, safety requirements, system dependability, automatic train control, audio and visual communications.

APM standard part 2 ASCE 21-98 – Vehicles, propulsion and braking.

APM standard part 3 ASCE 21-00 – Electrical equipment, stations, guideways.

With the permitted interval of 2 sec. and accounting for the basic capacity of a single module — 10 people — it is possible to ensure the peak traffic capacity of SkyWay transport system at 360,000 people per day in one direction (at 20-hour operation).

For the bidirectional system, the peak traffic capacity is 720,000 people per day. SkyWay efficiency may be raised by increasing modules capacity and uniting them in trains.

Model Range of Lightweight Innovative Passenger SkyWay Vehicles. UniBikes



UniBike U4-610

Single-seat UniBike
Number of passengers – 1
Total weight – 300 kg



UniBike U-61B

Single-seat UniBike
with bicycle generator
Number of passengers – 1
Total weight – 325 kg



UniBike U4-620

Double-seat UniBike
Number of passengers – 2
Total weight – 480 kg



UniBike U-62B

Double-seat UniBike
with bicycle generator
Number of passengers – 2
Total weight – 500 kg



UniBike U4-630

Three-seat UniBike
Number of passengers – 3
Total weight – 580 kg

A UniBike is a minimized suspended wheeled vehicle on steel wheels with the option of motion from muscle power of passengers, in addition to on-board (and external) power sources.

It combines the features of a transport system with a sports and entertainment object. The maximal motion speed is 120 km/h. As a result, one can quickly travel around a city.

Model Range of Innovative Urban Passenger SkyWay Vehicles

Large-sized double-rail



**Articulated Unibus
UniBus Tandem U4-22T3**
Number of passengers – 168
Total weight – 28,000 kg
Unladen weight – 15,400 kg

*Passengers total weight – 12,600 kg
Maximum speed – 150 km/h
Overall length L – 20,930 mm
Distance between module axes B – 3,085 mm*

Mid-sized monorail



UniBus U4-210
Number of passengers – 14
Passengers accommodation – sitting and standing, 4 sitting, 10 standing

*Total weight – 3,500 kg
Unladen weight – 2,450 kg
Passengers total weight – 1,050 kg
Maximum speed – 150 km/h*

Small-sized monorail



UniCar U4-410
Number of passengers – 3
Passengers accommodation – sitting, single-seat row

*Total weight – 500 kg
Unladen weight – 275 kg
Passengers total weight – 225 kg
Maximum speed – 120 km/h*



UniBus U4-220
Number of passengers – 28
Passengers accommodation – sitting and standing, 8 sitting, 20 standing

*Total weight – 5,000 kg
Unladen weight – 2,900 kg
Passengers total weight – 2,100 kg
Maximum speed – 150 km/h*



UniBus U4-211
Number of passengers – 3
Passengers accommodation – sitting and in a wheelchair

*Total weight – 2,690 kg
Unladen weight – 2,450 kg
Passengers total weight – 240 kg
Maximum speed – 150 km/h*



UniCar U4-411
Number of passengers – 2
Passengers accommodation – sitting, opposite row is single-seat

*Total weight – 425 kg
Total weight – 275 kg
Passengers total weight – 150 kg
Maximum speed – 120 km/h*



UniBus U4-221
Number of passengers – 7
Passengers accommodation – sitting and in a wheelchair

*Total weight – 3,440 kg
Unladen weight – 2,900 kg
Passengers total weight – 540 kg
Maximum speed – 150 km/h*



**Articulated Unibus
UniBus Tandem U4-21T6**
Number of passengers – 84
Total weight – 19,750 kg
Unladen weight – 13,450 kg

*Passengers total weight – 6,300 kg
Maximum speed – 150 km/h
Overall length L – 18,380 mm
Distance between module axes B – 2,830 mm*



UniCar U4-420
Number of passengers – 6
Passengers accommodation – sitting, double-seat row

*Total weight – 950 kg
Unladen weight – 500 kg
Passengers total weight – 450 kg
Maximum speed – 120 km/h*



**Articulated Unibus
UniBus Tandem U4-26T3**
Number of passengers – 84

*Total weight – 19,750 kg
Unladen weight – 13,450 kg
Passengers total weight – 6,300 kg
Maximum speed – 150 km/h
Overall length L – 18,380 mm
Distance between module axes B – 2,830 mm*



UniCar U4-421
Number of passengers – 4
Passengers accommodation – sitting, double-seat row

*Total weight – 800 kg
Unladen weight – 500 kg
Passengers total weight – 300 kg
Maximum speed – 120 km/h*



UniBus U4-260
Number of passengers – 14
Passengers accommodation – sitting and standing, 4 sitting, 10 standing

*Total weight – 3,500 kg
Unladen weight – 2,450 kg
Passengers total weight – 1,050 kg
Maximum speed – 150 km/h*

According to SkyWay technology, the innovative urban vehicle has a principle of modular construction for both nodal solutions and the structure of a rail unibus itself, as well as operatorless control on the route based on software control on the autopilot principle.

The principle of unibus modularity gives a customer a possibility to choose the optimal rolling stock at minimum cost.

Model Range of Innovative High-Speed Intercity Passenger SkyWay Vehicles

Unibus U4-361

High-speed
Double-rail
Mounted
Single-row

Number of passengers – 4
Cargo capacity – 400 kg
Total weight – 2,000 kg
Unladen weight – 1,600 kg
Maximum speed – 450 km/h



Unibus U4-365

High-speed
Double-rail
Mounted
Double-row with an aisle and a lavatory

Number of passengers – 8
Cargo capacity – 800 kg
Total weight – 5,000 kg
Unladen weight – 4,200 kg
Maximum speed – 450 km/h



Unibus U4-362

High-speed
Double-rail
Mounted
Double-row

Number of passengers – 8
Cargo capacity – 800 kg
Total weight – 3,500 kg
Unladen weight – 2,700 kg
Maximum speed – 450 km/h



Unibus U4-365T

High-speed train
Double-rail
Mounted
Double-row with an aisle and a lavatory

Number of passengers – 24
Cargo capacity – 2,400 kg
Total weight – 15,000 kg
Unladen weight – 12,600 kg
Maximum speed – 450 km/h



Unibus U4-363

High-speed
Double-rail
Mounted
Three-row

Number of passengers – 12
Cargo capacity – 1,200 kg
Total weight – 5,000 kg
Unladen weight – 3,800 kg
Maximum speed – 450 km/h



A high-speed unibus is a mounted vehicle on steel wheels allowing to move quickly to a distance of up to 10,000 km. Driving at a high speed is ensured due to special design of the track structure and low aerodynamic resistance of the vehicle.

The maximum motion speed will be up to 500 km/h, as a result of which a high-speed unibus is ideal for intercity transportation.

Model Range of Innovative Cargo SkyWay Vehicles



UniTruck U4-131

Single cargo vehicle
(mono-rail, suspended)

Cargo Unitruck for bulk cargo transportation.
Total weight – 2,500 kg
Section capacity – 0.75 m³
Performance – up to 200 mln t/year



UniTruck U4-133

Single cargo vehicle
(mono-rail, suspended)

Cargo Unitruck for liquid cargo transportation.
Total weight – 2,500 kg
Section capacity – 1 m³
Performance – up to 200 mln t/year



UniTruck U4-137

Single cargo vehicle
(mono-rail, suspended)

Cargo Unitruck for break-bulk cargo transportation (Europallets, pallets).
Total weight - 2,500 kg
Section capacity – 2 m³
Performance – up to 200 mln t/year

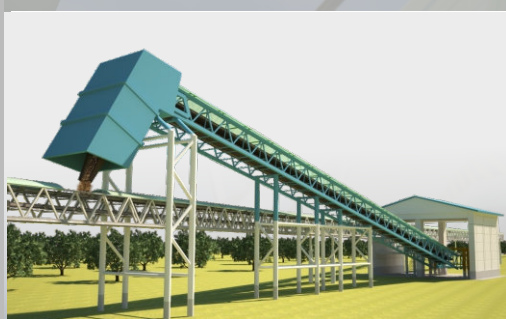

UniTrans U4-100

Loop conveyor (transporter)
on wheel pairs with a turn in horizontal plane.

Performance – up to 200 mln t/year

Cargo SkyWay and cargo vehicle – Unicar

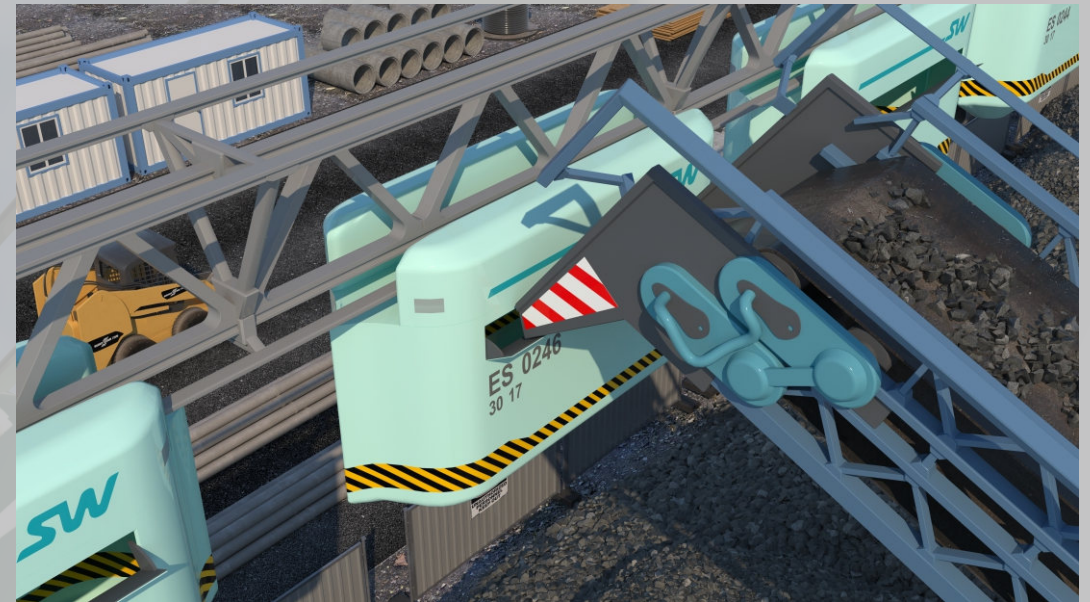

A cargo rolling stock will be made on the basis of suspended urban passenger minibuses. Consequently, the maximal weight, speed and bogie are completely unified with the passenger transport. A cargo unicar body can have the following modifications: for break-bulk cargo (Europallets), for bulk and liquid cargo.



International RECOGNITION of SkyWay

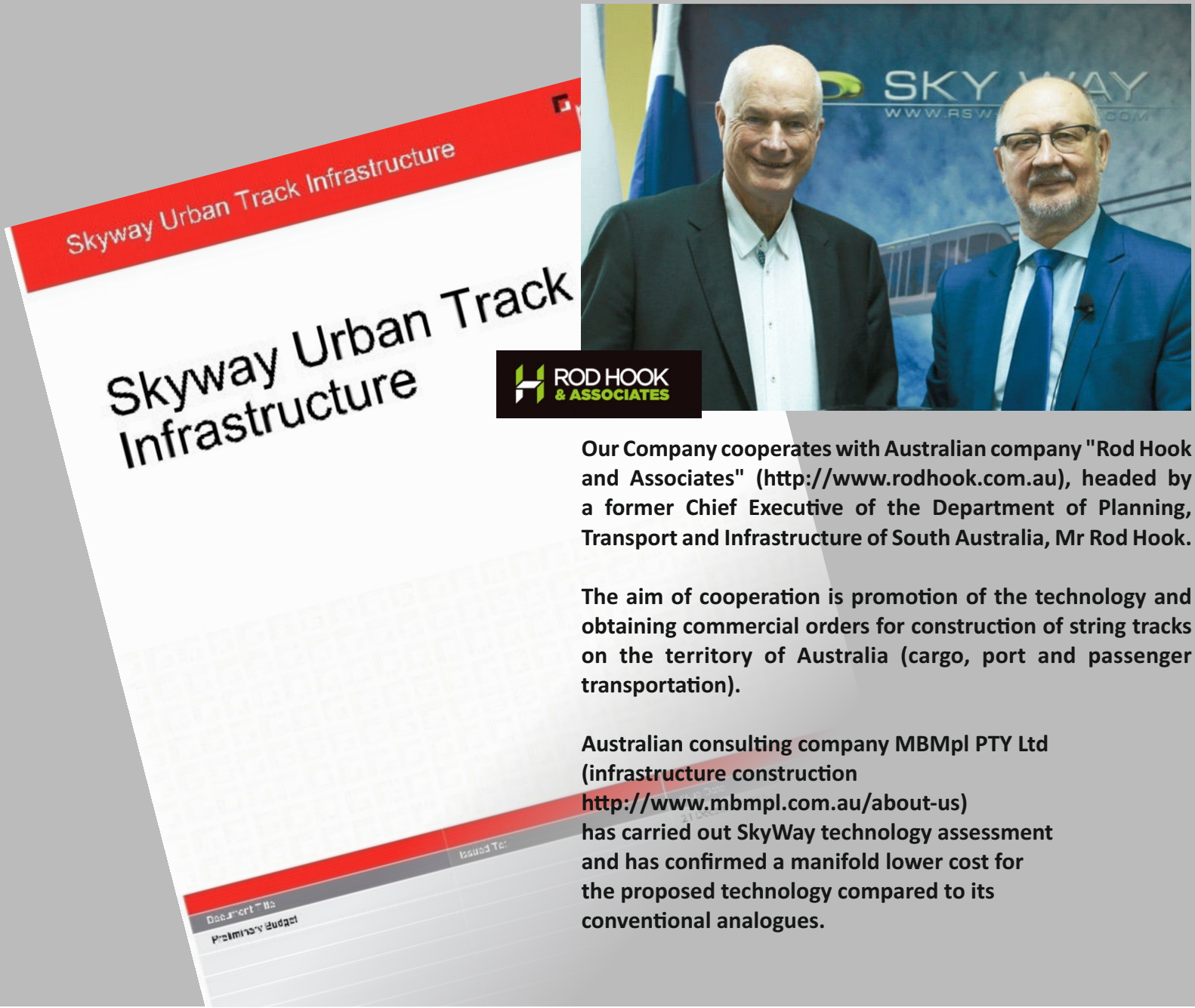

Our Company cooperates with Australian company "Rod Hook and Associates" (<http://www.rodhook.com.au>), headed by a former Chief Executive of the Department of Planning, Transport and Infrastructure of South Australia, Mr Rod Hook.

The aim of cooperation is promotion of the technology and obtaining commercial orders for construction of string tracks on the territory of Australia (cargo, port and passenger transportation).

Australian consulting company MBMpl PTY Ltd (infrastructure construction <http://www.mbmpl.com.au/about-us>) has carried out SkyWay technology assessment and has confirmed a manifold lower cost for the proposed technology compared to its conventional analogues.

Prospects for SkyWay Technology Application in the Russian Federation

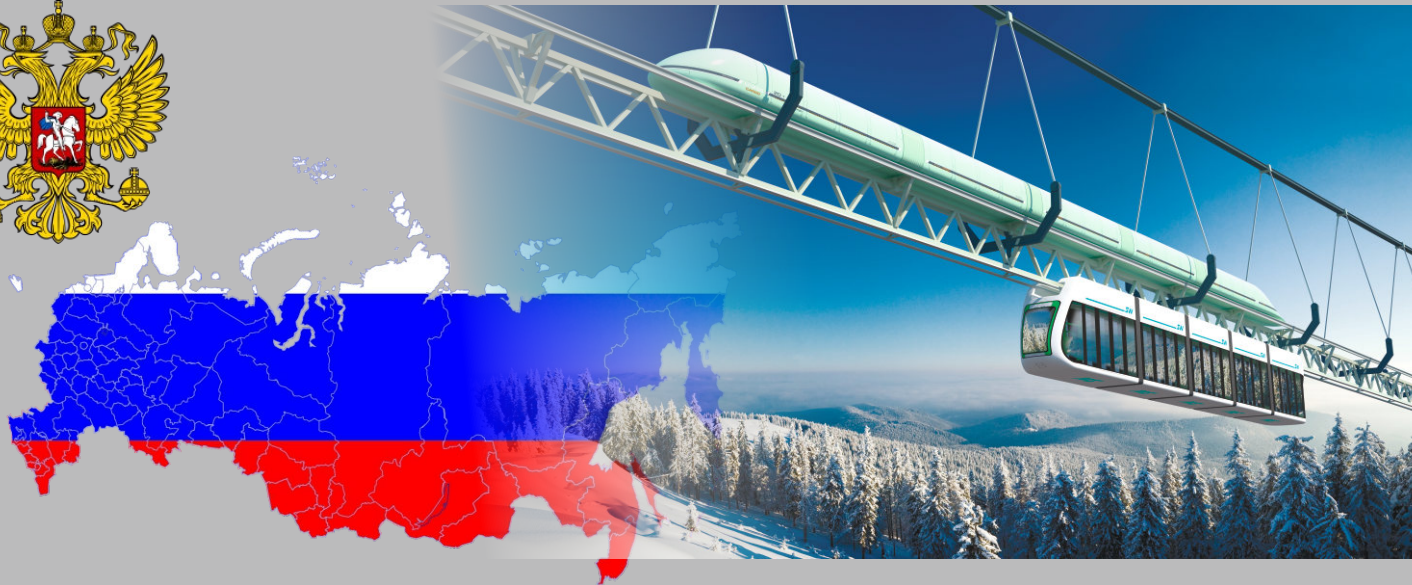

- Exploration and development of underdeveloped and hard-to-reach territories, creation of a single network for cargo, urban and high-speed inter-city tracks
- Maximal reduction of capital and operating expenses for transport and infrastructure construction
- Qualitative change in the economic order and increase in the country GDP
- Integration of Russia into international transport corridors between Europe and Asia and creation of a fundamentally new logistics of the 21st century
- Development of related branches for track structure and rolling stock manufacture (metallurgy, chemical, petrochemical and radio-electronic industries, mechanic engineering, construction, etc.)

Import substitution



Track structure



Rolling stock

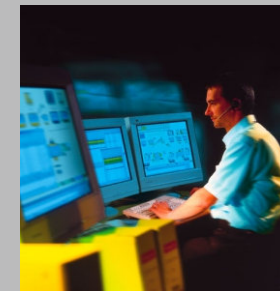

Automatic Control Systems

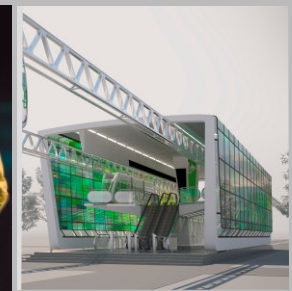

Infrastructure

All innovative components SkyWay can be manufactured using the Russian technological base

Sky Way Solution for Russian Regions

String transport (SkyWay) is a project of promising infrastructure technology. It provides innovative transport and logistics solutions for regions with harsh natural, climatic and infrastructure conditions. In addition, it ensures year-round transport connection of large traffic arteries with northern coasts of the country.

Variants of local transport and infrastructure solutions:

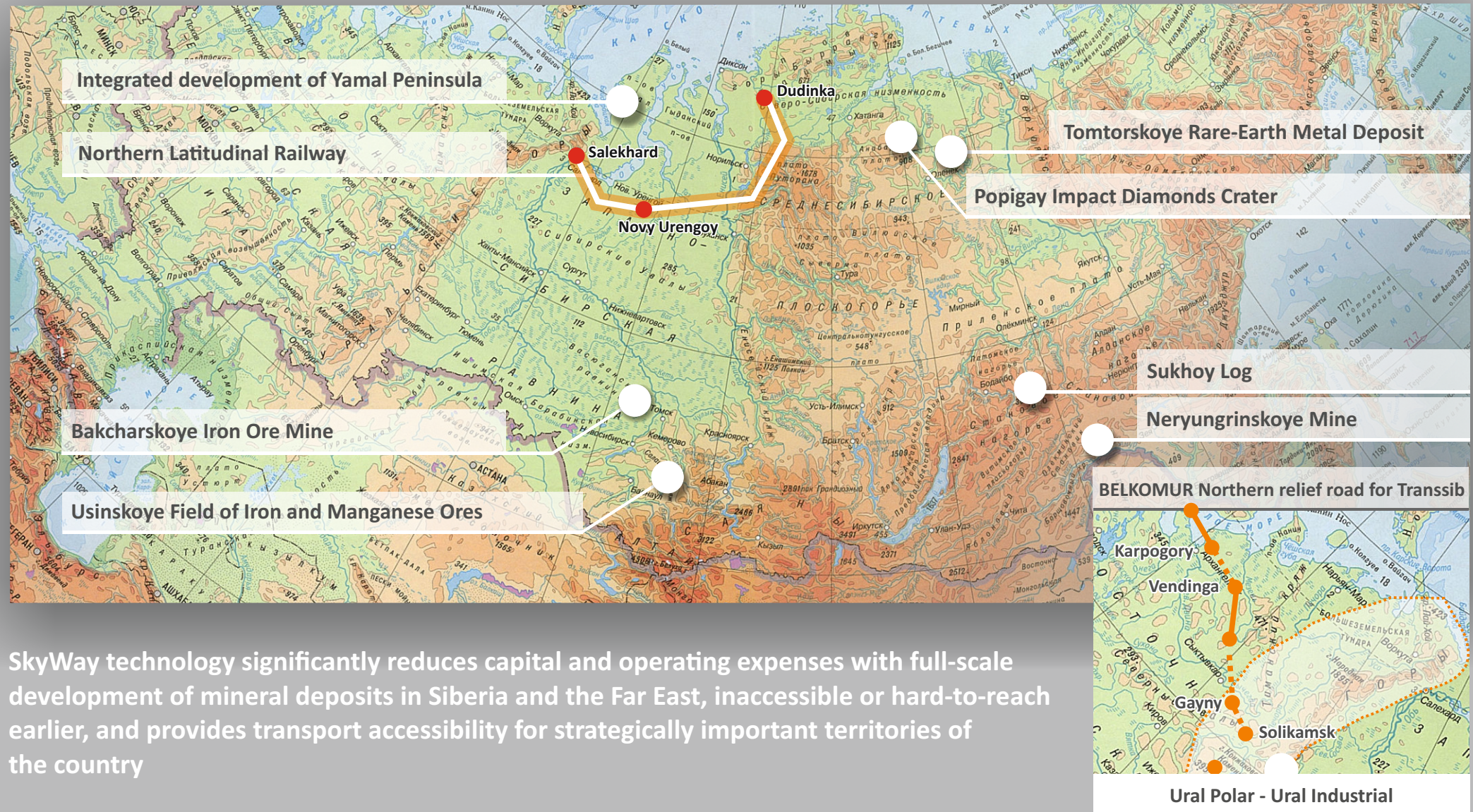

SkyWay technology significantly reduces capital and operating expenses with full-scale development of mineral deposits in Siberia and the Far East, inaccessible or hard-to-reach earlier, and provides transport accessibility for strategically important territories of the country

Our Competitors



HYPERLOOP



Hyperloop

The technology of high-speed transport system, developed by American billionaire Elon Musk, the founder of companies Space X and Tesla Motors; according to it, movement is carried out on an air cushion in a vacuum tube.

SkyWay is by 10-15 times cheaper and more effective

skyTran™



SkyTran

The technology of passenger transportation using personal vehicles operating on a magnetic cushion is developed by an Israeli company SkyTran with the support of Space agency NASA (USA).

SkyWay is by 3-5 times cheaper and more effective

Contact details



104, building B, Dzerzhinskogo Ave.,
Minsk, 220116, Republic of Belarus
phone/fax: +375 17 388-20-20
<http://sw-tech.by>
info@sw-tech.by